

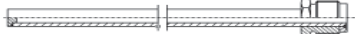





Thermometer Protection Tubes and Extension Pipes metallic, according to DIN 43 772

The following illustrations show the different designs and forms.
The forms in italics correspond to the withdrawn standard DIN 43 763.

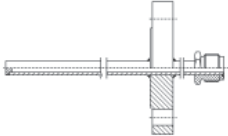
Form 1 /Form A Page 2	Form 2 /Form A Page 3	Form 2G /Form B&C Page 4
Plug-in or weld-in straight protection tube 	Plug-in or weld-in straight protection tube 	Screw-in straight protection tube 
Form 2F /Form F Page 5	Form 3 /Form E Page 6	Form 3G /Form G Page 7
Straight protection tube with flange 	Plug-in or weld-in reduced straight protection tube 	Screw-in reduced straight protection tube 
Form 3F /Form F Page 8	Form 4 /Form D Page 9	Extension Pipe Page 10
Reduced protection tube with flange 	Weld-in conical thermowell for high pressures 	For thermowells form 4 

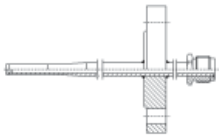
The suitable measuring inserts are also listed with their lengths. They are available as resistance thermometers or thermocouples both in tube or MI-sheath design. Please see our Product Information 176 "Measuring Inserts" for more informations.

Further one-side closed protection tubes made of ceramic or metallic materials can be found in the Product Information 172 „Straight Thermocouples“.

Accessories like e.g. stop flanges, threaded bushings, compression fittings, connection cables etc. are partially available from stock.

Standard connection heads made of aluminium or plastic are also available as well as are those with enlarged cap for the mounting of up to two transmitters. Our range of temperature transmitters can be found in the Product Information „TMU“.

For further informations please visit our website under: <Support> <Product Information>

1) Plug-in or Weld-in Protection Tube Form 1 (Form A)

Ordering code

Example: Protection tube A 15 R - 730

Protection tube

DIN 43 763 <> DIN 43 772

Form A = Form 1

Prot. tube outer-Ø in mm

Protection tube material

Identification letter see table page 11

Total protection tube length

in mm

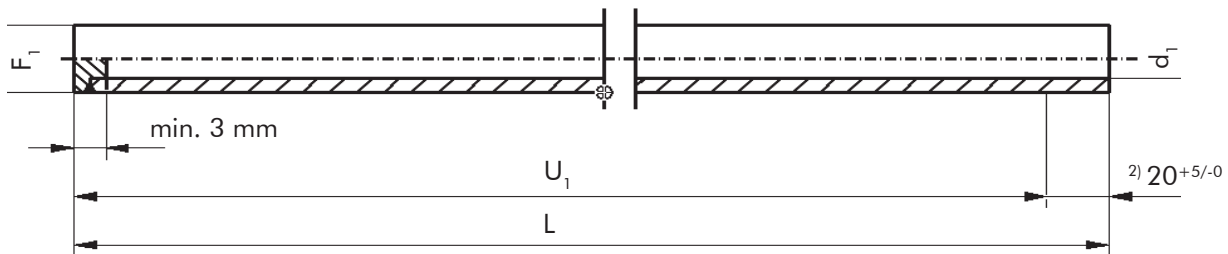
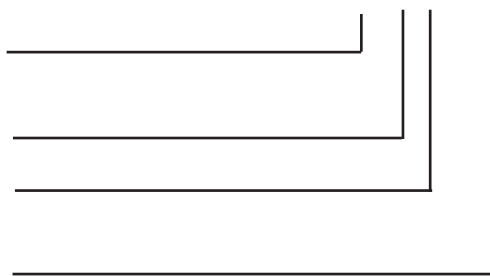

All dimensions are given in mm

Total length L in mm	Nominal length U_1 in mm	Outer diameter F_1 in mm	Inner diameter d_1 in mm	Measuring insert length for con- nection head form B in mm	Measuring insert length for con- nection head form A in mm
520	500	15 ^{1,2)}	11	525	545
730	710			735	755
1020	1000	22 ^{1,2)}	18	1025	1045
1420	1400	32 ^{1,3)}	28	1425	1445
2020	2000			2025	2045

1) These protection tube diameters are preferably used for straight thermocouples as per our Product Information 172. A selection of protection tube materials can be found on page 11 of this brochure.

2) Upon request this protection tube made of material no. 1.0305 (St 35.8) can be coated with different enamellings. The outer diameter will then increase by approx. 2 mm; from the open end approx. 20 mm remain uncoated.

3) Protection tubes with a diameter of 32 mm can only be fitted with connection heads form A.

Coatings respectively surface treatments are available upon request, as well as other dimensions and lengths up to 6000 mm. For further details see page 11.

For installation lengths over 1400 mm and horizontal mounting an additional support is recommended.

The bottom of the protection tubes Form 1 can also be dished or welded contrary to the above illustration. Seen technically, this design is completely equivalent for nominal pressure level 1.

Mounting accessories like e.g. stop flanges, threaded bushings, compression fittings etc. are available upon request and almost available from stock.

2) Plug-in or Weld-in Protection Tube Form 2

Ordering code Example: Protection tube A14 x 2.5 x 280 / 305 - 1.4571

Protection tube
DIN 43 763 <> DIN 43 772
--- = Form 2

Prot. tube outer-Ø in mm

Wall thickness in mm

Nominal length in mm

Total length in mm

Protection tube material

Materials see table page 11

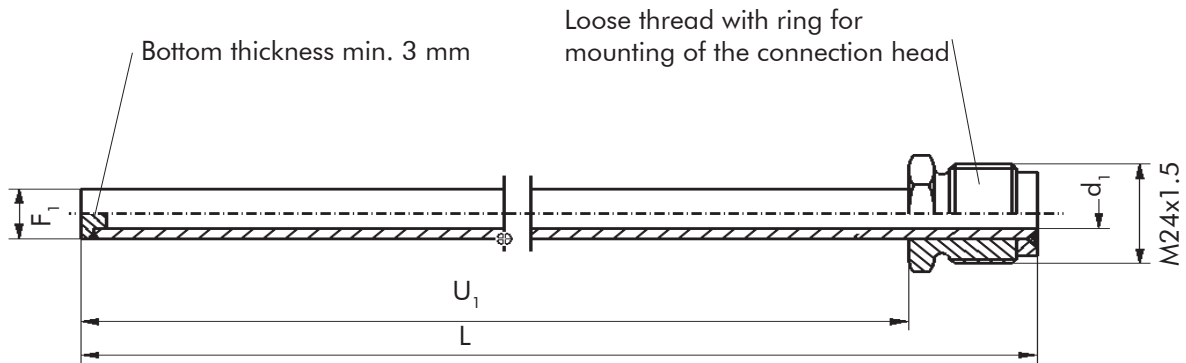
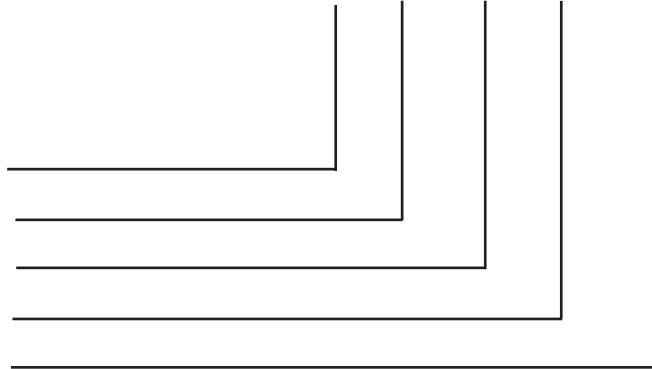

All dimensions are given in mm

Form DIN 43763	Form DIN 43772	Total length L in mm	Nominal length U ₁ in mm	Inner length in mm	Process connection	Outer dia- meter F ₁ in mm	Inner diameter d ₁ in mm	Measuring insert length for conn. head Form B	
Not included in DIN 43 763	2	305	280	302	To be deter- mined by user	9	7	315 / Ø 6	
		395	370	392				405 / Ø 6	
		545	520	542				555 / Ø 6	
	2	2	305	280		302	11	7 or 9	315 / Ø 6 or Ø 8
			395	370		392			405 / Ø 6 or Ø 8
			545	520		542			555 / Ø 6 or Ø 8
	2	2	305	280		302	12	7	315 / Ø 6
			395	370		392			405 / Ø 6
			545	520		542			555 / Ø 6
	2	2	305	280		302	14	9	315 / Ø 8
			395	370		392			405 / Ø 8
			545	520		542			555 / Ø 8

All components are preferably made of material no. 1.4571 (SS 316 TI). Other materials and/or coatings are available upon request. See also page 11. In addition to the standard lengths listed in the table other lengths are available upon request.

3) Screw-in Protection Tube Form 2G (Form B and C)

Ordering code

Screw-in protection tube
 DIN 43763 <> DIN 43772
 B (B1 to B3) = Form 2G
 C (C1 and C2) = Form 2G
 Prot. tube outer-Ø in mm
 Protection tube material
 Identification letter see table page 11
 Ext. pipe length in mm from
 bottom edge of pipe screw joint
 Installation length in mm
 Screw-in spigot thread
 Form B = G 1/2" B (M18 x 1.5);
 Form C = G 1" B (M27 x 2)

Example: B 11 J - 120/160, G1/2"

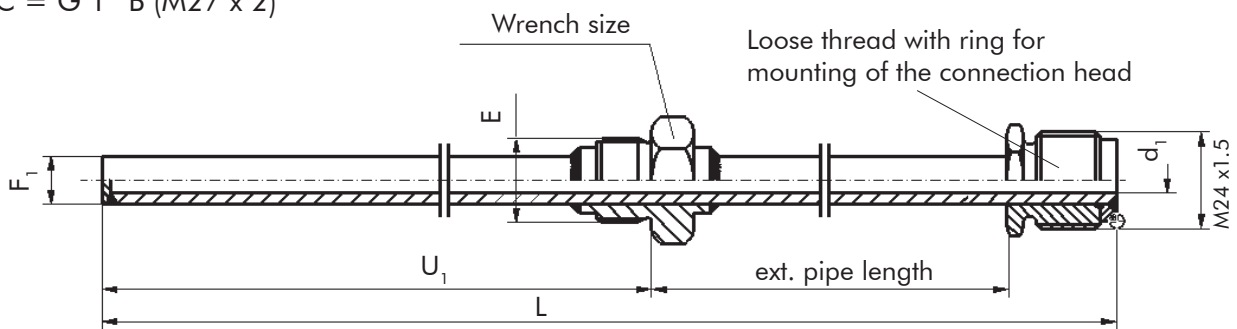
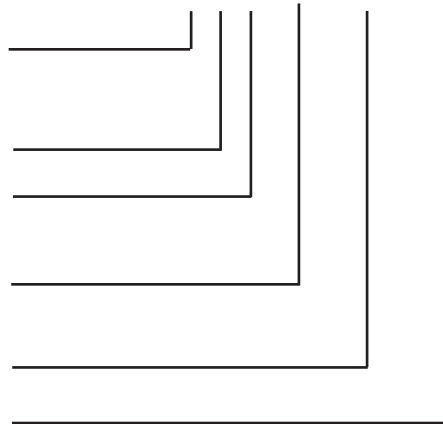

All dimensions are given in mm

Form DIN 43763	Form DIN 43772	Total length L in mm	Install. length U ₁ in mm	Extension pipe length in mm	Process connection thread E	Outer dia- meter F ₁ in mm	Inner diameter d ₁ in mm	Measuring insert length for connec- tion head form B		
B	2 G	305	160	Protect. tube length 120 mm (145 mm – DIN 43 772)	G 1/2" B (M18 x 1.5)	9	7	315 / Ø 6		
		395	250					405 / Ø 6		
		545	400					555 / Ø 6		
B	2 G	305	160		Protect. tube length 145 mm (170 mm – DIN 43 772)	G 1/2" B (M18 x 1.5)	11	7 or 9	315 / Ø 6 or Ø 8	
		395	250						405 / Ø 6 or Ø 8	
		545	400						555 / Ø 6 or Ø 8	
B	2 G	305	160			Protect. tube length 145 mm (170 mm – DIN 43 772)	G 1/2" B (M18 x 1.5)	12	7	315 / Ø 6
		395	250							405 / Ø 6
		545	400							555 / Ø 6
C	2 G	330	160	Protect. tube length 145 mm (170 mm – DIN 43 772)			G 1" B (M27 x 2)	11	7 or 9	340 / Ø 6 or Ø 8
		420	250							430 / Ø 6 or Ø 8
		570	400							580 / Ø 6 or Ø 8
C	2 G	330	160		Protect. tube length 145 mm (170 mm – DIN 43 772)		G 1" B (M27 x 2)	12	7	340 / Ø 6
		420	250							430 / Ø 6
		570	400							580 / Ø 6
C	2 G	330	160			Protect. tube length 145 mm (170 mm – DIN 43 772)	G 1" B (M27 x 2)	14	9	340 / Ø 8
		420	250							430 / Ø 8
		570	400							580 / Ø 8

Forms B and C of the withdrawn standard DIN 43 763 were transferred as form 2G to the DIN 43 772. All components are preferably made of material no. 1.4571 (SS 316 Ti). The screw-in spigot is welded onto a through tube with welded-in bottom. In addition to the protection tubes listed in the table above special designs as well as other materials are available on request.

4) Straight Protection Tube Form 2F with Flange

Ordering code

Example: F 1/305, 80, 225, 1.4571, 05B1, 25/40

Protection tube with flange
DIN 43 763 <> DIN 43 772
--- = Form 2F

Total length in mm

Extension pipe length in mm

Protection tube installation length

Protection tube material no.
Materials see table page 11

Flange acc. to EN 1092-1

Nominal diameter (DN) /
Nominal pressure (PN)

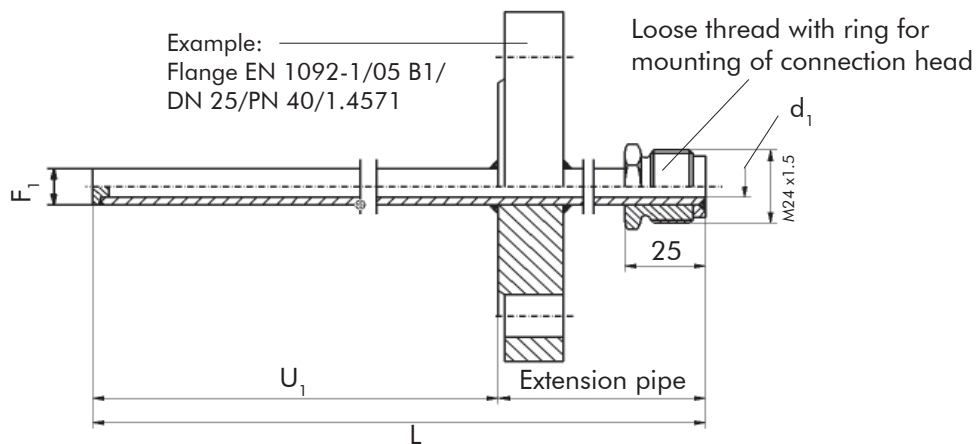
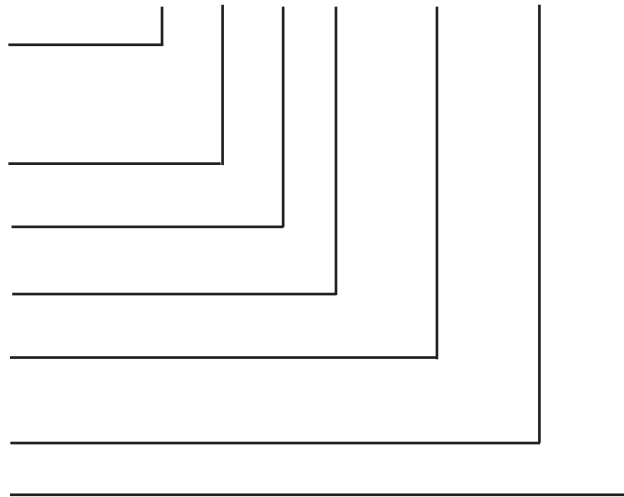

All dimensions are given in mm

Form DIN 43763	Form DIN 43772	Total length L	Installation length U ₁	Extension tube length	Process connection	Outer diam- eter F ₁	Inner diameter d ₁	Measuring insert length for connec- tion head form B			
(F)	2 F	305	225	80	Flange acc. to customer specification	9	7	315 / Ø 6			
		395	315					405 / Ø 6			
		545	465					555 / Ø 6			
(F)	2 F	305	225	80		Flange acc. to customer specification	11	7 or 9	315 / Ø6 or Ø 8		
		395	315						405 / Ø6 or Ø 8		
		545	465						555 / Ø6 or Ø 8		
(F)	2 F	305	225	80			Flange acc. to customer specification	12	7	315 / Ø 6	
		395	315							405 / Ø 6	
		545	465							555 / Ø 6	
(F)	2 F	305	225	80				Flange acc. to customer specification	14	9	315 / Ø 8
		395	315								405 / Ø 8
		545	465								555 / Ø 8

All components are preferably made of material no. 1.4571. The flange is welded onto a tube with welded-in bottom. In addition to the standard lengths listed in the table above other lengths and materials are available on request. Always specify the type of flange in detail. The above data are just an example.

5) Plug-in or Weld-in Reduced Protection Tube Form 3 (Form E)

Ordering code

Example: E 1/307, 1.4571

Reduced protection tube
DIN 43 763 <> DIN 43 772
E (E1 to E3) = Form 3

Total length in mm

Protection tube material no.
Materials see table page 11

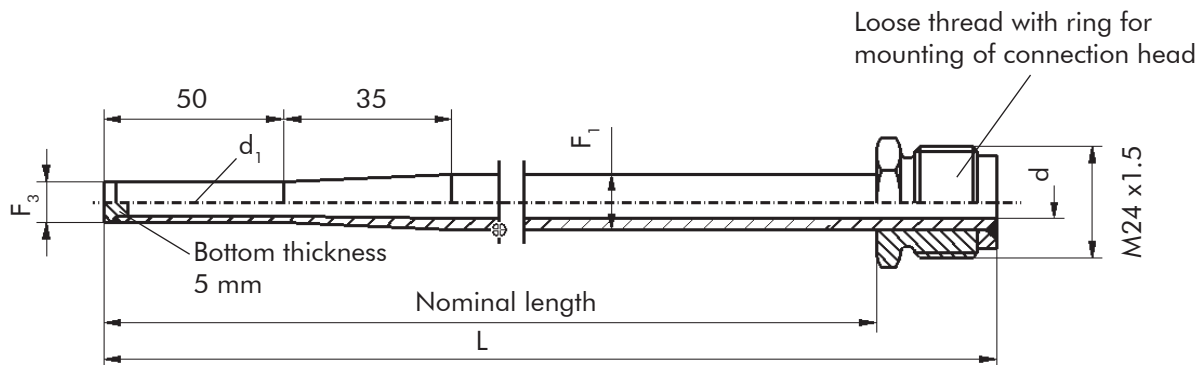
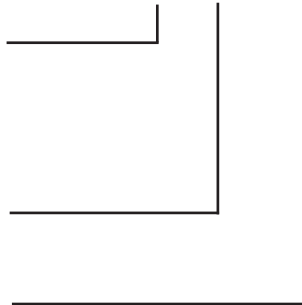

All dimensions are given in mm

Form DIN 43763	Form DIN 43772	Total length L in mm	Nominal length in mm	Recommended installation length in mm	Outer dia- meter F ₁ in mm	Reduced diameter F ₃ in mm	Red. inner diameter d ₁ in mm	Measuring insert length for connec- tion head form B
E 1	3	307	282	225	12 (d = 7)	9	6 +0.1/+0.05	315 / Ø 6
E 2		367	342	285				375 / Ø 6
E 3		427	402	345				435 / Ø 6
E 1	3	307	282	225	14 (d = 9)	11	8 +0.1/+0.05	315 / Ø 8
E 2		367	342	285				375 / Ø 8
E 3		427	402	345				435 / Ø 8

All components are made of material no. 1.4571. The tube is reduced in the area of the measuring head to obtain better (shorter) response times.

Coatings resp. surface treatments are available on request as well as different materials, dimensions and lengths.

In the area of the reduced measuring head the tolerances of the inner dia. are narrower. It must therefore be taken into account that only measuring inserts with the identification numbers 60 (dia. 6.0 +0/-0.1) resp. 80 (dia. 8.0 +0/-0.1) can be used. See also DIN 43 735 / 43 765

6) Screw-in Reduced Protection Tube Form 3G (Form G)

Ordering code

Example: G 1 / 307, 147 / 160, 1.4571, G1"

Screw-in red. protection tube
DIN 43 763 <> DIN 43 772
G (G1 to G3) = Form 3G

Total length in mm

Extension pipe length in mm incl.
ring and pipe screw joint

Installation length in mm

Protection tube material no.
Materials see table page 11

Process connection thread E

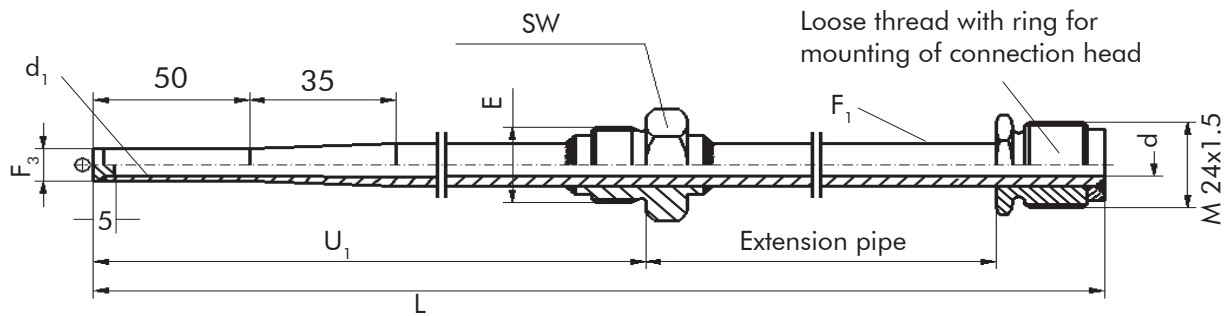
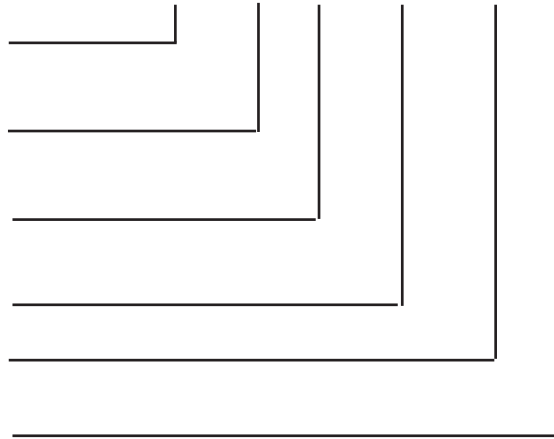

All dimensions are given in mm

Form DIN 43763	Form DIN 43772	Total length L	Installation length U ₁	Extension pipe length	Process connection thread E	Outer diameter F ₁	Red. outer diameter F ₃	Red. inner diameter d ₁	Measuring insert length for connec- tion head form B		
G 1	3 G	307	160	Extension pipe 122 mm (147 mm - DIN 43 772)	G 1/2" B (M18x1.5) G 3/4" B (M22x1.5) G 1" B (M27 x 2)	12 (d = 7)	9	6 +0.1/+0.05	315 / Ø 6		
G 2		367	220						375 / Ø 6		
G 3		427	280						435 / Ø 6		
G 1	3 G	307	160			G 1/2" B (M18x1.5) G 3/4" B (M22x1.5) G 1" B (M27 x 2)	14 (d = 9)	11	8 +0.1/+0.05	315 / Ø 8	
G 2		367	220							375 / Ø 8	
G 3		427	280							435 / Ø 8	
G 1	3 G	307	160				G 1" B (M27 x 2)	14 (d = 9)	11	8 +0.1/+0.05	315 / Ø 8
G 2		367	220								375 / Ø 8
G 3		427	280								435 / Ø 8

All components are made of material no. 1.4571. The screw-in spigot is welded onto a tube with welded-in bottom. The tube is reduced in the area of the measuring head to obtain a better (shorter) response time.

Coatings resp. surface treatments are available on request as well as different materials, dimensions and lengths. For further details see page 11.

In the area of the reduced measuring head the tolerances of the inner dia. are narrower. It must therefore be taken into account that only measuring inserts with the identification numbers 60 (dia. 6.0 +0/-0.1) resp. 80 (dia. 8.0 +0/-0.1) can be used. See also DIN 43735 / 43765.

7) Reduced Protection Tube Form 3F (Form F) with Flange

Ordering code

Example: F 1/307, 82, 225, 1.4571, 05B1, 25/40

Protection tube with flange
DIN 43 763 <> DIN 43 772
F (F1 to F3) = Form 3F
Total length in mm

Total length of the
extension pipe in mm

Protection tube inst. length

Protection tube material no.
Material see table page 11

Flange EN 1092-1

Nominal diam. (DN) /
Nominal pressure (PN)

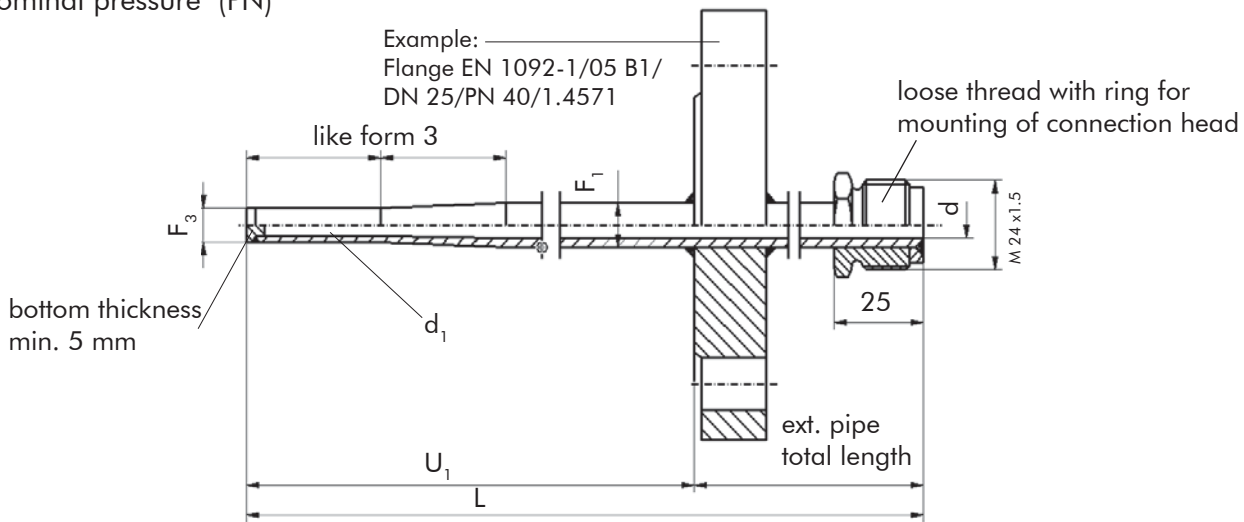
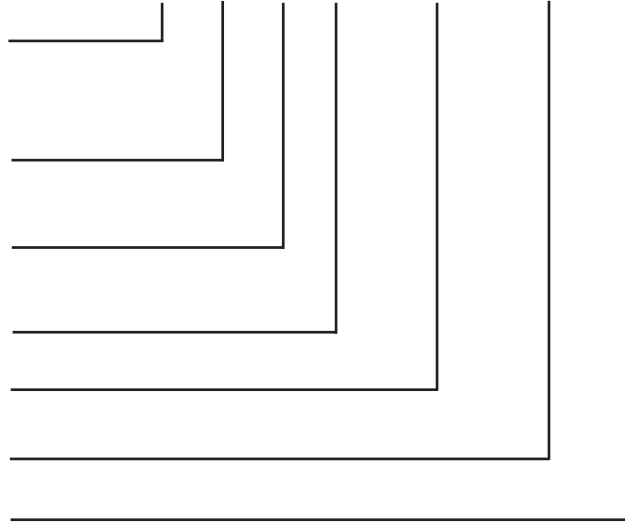

All dimensions are given in mm

Form DIN 43 763	Form DIN 43 772	Total length L	Installation length U_1	Ext. pipe total length	Process connection	Outer dia- meter F_1	Red. outer diameter F_3	Red. inner diameter d	Measuring insert length for connec- tion head form B	
F	3 F	307	225	82	Flange acc. to cus- tomer specification	12 (d = 7)	9	6 +0.1/+0.05	315 / Ø 6	
		367	285						375 / Ø 6	
		427	345						435 / Ø 6	
F	3 F	307	225	82		Flange acc. to cus- tomer specification	14 (d = 9)	11	8 +0.1/+0.05	315 / Ø 8
		367	285							375 / Ø 8
		427	345							435 / Ø 8

All components are made of material no. 1.4571. The flange is welded onto a tube with welded-in bottom. The tube is reduced in the area of the measuring head to obtain better (shorter) response times.

Coatings resp. surface treatments are available on request as well as different materials, dimensions and lengths. For further details see page 11.

In the area of the reduced measuring head the tolerances of the inner dia. are narrower. It must therefore be taken into account that only measuring inserts with the identification numbers 60 (dia. 6.0 +0/-0.1) resp. 80 (dia. 8.0 +0/-0.1) can be used.

8) Weld-in Protection Tube (Thermowell) Form 4 (Form D)

Ordering code

Example: Form 4-7-M18x1.5-200-65-16Mo3 (or CH or 1.5415)

Thermowell

DIN 43763 <> DIN 43772

D (D1 to D5) = Form 4

Inner diameter d_1 in mm

Extension pipe thread N

Total length L in mm

Insertion (cone) length U in mm

Material short name
or identification letter
or material no.

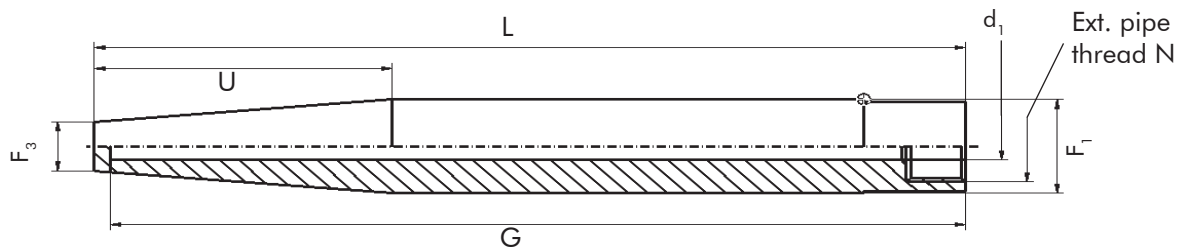
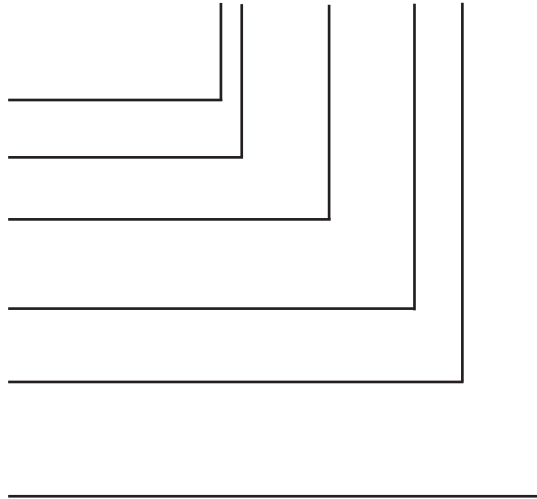

All dimensions are given in mm

Form DIN 43763	Form DIN 43772	Total length L in mm	Cone length U in mm	Inner length G in mm	Ext. pipe thread N	Outer dia- meter in mm	Inner diameter d_1 in mm	Measuring insert length for head form B & 140 mm extension pipe
---	4	110	65	105	M 18 x 1,5	$F_1 = 24 h7$ $F_3 = 12.5$	7	285 / Ø 6
---		110	73	105				285 / Ø 6
D 1		140	65	135				315 / Ø 6
---		170	133	165				345 / Ø 6
D 4		200	65	195				375 / Ø 6
D 2		200	125	195				375 / Ø 6
D 5		260	125	255				435 / Ø 6
---		410	275	405				585 / Ø 6
---	4	110	65	105	M 14 x 1,5	$F_1 = 18 h7$ $F_3 = 9$	3,5	285 / Ø 3
---		110	73	105				285 / Ø 3
(D1S / DS 3)		140	65	135				315 / Ø 3
---		170	133	165				345 / Ø 3
(D4S / DS 2)		200	65	195				375 / Ø 3
(D2S / DS 4)		200	125	195				375 / Ø 3
(D5S)		260	125	255				435 / Ø 3

In addition to the standard designs listed in the table above other outer and inner diameters as well as lengths are available on request. Material see table page 11.

9) Extension Pipe for Form 4 (Form D)

Ordering code

Example: Ext. pipe 14x2.5 - 140/165 - M24x1.5 / M18x1.5 - 1.4571

Extension pipe

DIN 43 763 <> DIN 43 772

--- = Ext. pipe

Ø F₁ x wall thickness

Extension pipe length in mm

Total length M in mm

Pipe screw joint

Screw-in thread N

Material no.

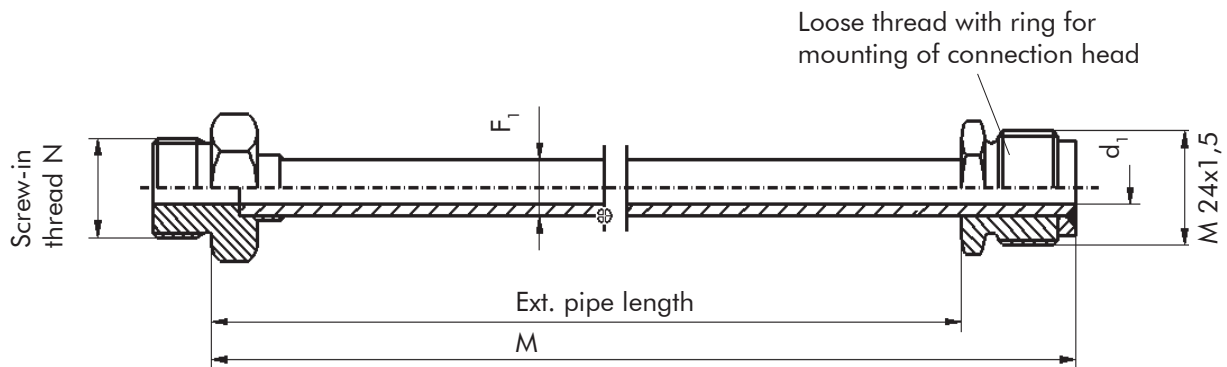
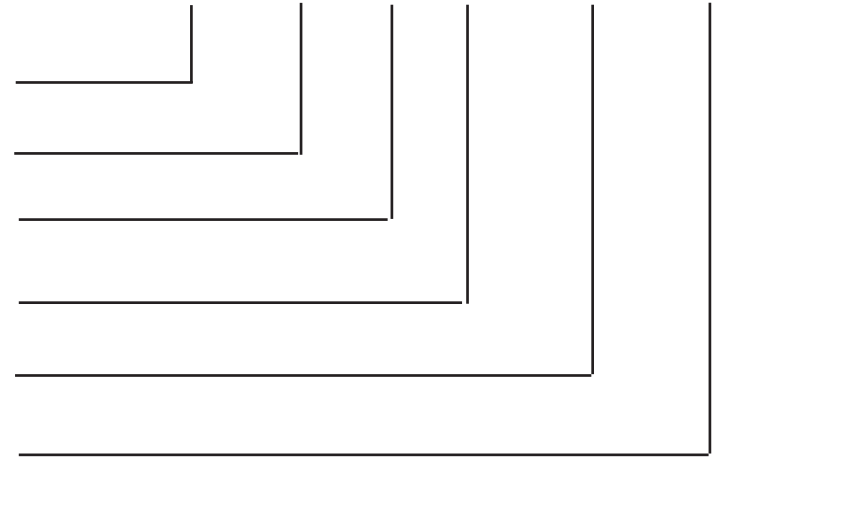

Total length M in mm	Extension pipe length in mm	Screw-in thread N	Pipe screw joint (SW 24)	Outer diameter F ₁ in mm	Inner diameter d ₁ in mm
165	140	M14 x 1.5 / SW 17	M24 x 1.5	11	7
165	140	M18 x 1.5 / SW 24	M24 x 1.5	14	9

All components are preferably made of material no. 1.4571. Screw-in spigot, pipe and ring are normally welded. Other materials and/or coatings are available on request.

In addition to the standard lengths listed in the table above other outer and inner diameters, lengths and surface treatments are available on request.

The extension pipe can be used without modifications also for form 4F as well as forms 5 - 9 acc. to DIN 43 772 (forms BD, BE, BS, CD, CE and CS acc. to DIN 16179).

10) Standard Designs of Protection Tubes

- Form 1: If the protection tubes are to be supplied with a coating on request by the customer, e.g. of enamel, the open end of the protection tube remains uncoated for min. 20 mm.
- Forms 2, 3, 3G & 3F: The semi-finished products for the protection tubes are annealed and free of oxide. The welding at the protection tube head are made under inert gas. The lock ring is welded.
- Form 2G, 2F, 3G, 3F & 4F: The protection tubes are inserted into the screw-in spigot resp. flange, and are typically welded to the lower and upper edge of the screw-in spigot resp. of the flange. The welding seam on the process side is made first.
- Form 4: The protection tube (thermowell) is made from solid bar stock.
- Form 4F: The protection tube is inserted into the flange and typically welded to the lower and upper edge of the flange. The welding seam on the process side is made first.
- All forms: Acceptance certificates acc. to EN 10 204-2.1, -2.2, -3.1 and -3.2 as well as individual test certificates (PMI) are available on request, preferably for the parts in contact with media. Coatings resp. surface treatments, like e.g. TEFLON, HALAR, PFA, annealing QPQ, stellite coating and similar, are available on request

11) Recommendations on the Selection of Protection Tube Materials

All recommendations are given without liability and do not constitute guaranteed properties. Coatings on protection tubes do normally not increase the operating temperature, but provide only a special protection against chemical attacks, corrosion or abrasion. All these recommendations are to be checked and verified by the customer with regard to the intended individual application.

The right to modifications, which serve technical progress, is reserved.

Material for protection tubes

Ident. letter(s) (Optional)	Short name	Material No. AISI or ASTM	Operating temp. (Recommended)
BF	St 35.8	1.0305 (A 106 A)	400 °C
BL	C 22.8	1.0460 (A 105)	450 °C
J	X 6 CrNiMoTi 17-12-2	1.4571 (316 TI)	600 °C
DU	X 18 CrNi 28	1.4749 (446)	1100 °C
R	X 10 CrAl 24	1.4762 (441)	1100 °C
D	X 15 CrNiSi 2520	1.4841 (310 / 314)	1200 °C
B	INCONEL 600	2.4816	1300 °C
	X10CrMoVNb 12-1	1.4903 (P 91)	680 °C
	X10CrMoWNb 9-1-1	1.4905 (---)	730 °C
	X11CrMoWNb 9-3-1	1.4901 (P 92)	730 °C
	Alloy 617 (NiCr23Co12Mo)	2.4663	730 °C
CH	16 Mo 3	1.5415 (A 204)	600 °C
BB	13 Cr Mo 44	1.7335 (A182-F11)	600 °C
BA	10 Cr Mo 910	1.7380 (A182-F22i)	600 °C

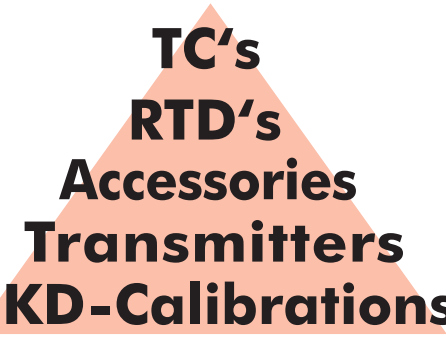

TC's
RTD's
Accessories
Transmitters
DKD-Calibrations

- ▲ High-temperature thermocouples up to 2300 °C
 - ▲ Profile and multipoint thermocouples
 - ▲ Special designs to customer specifications
 - ▲ MI thermocouples (ATEX)
 - ▲ Thermocouple measuring inserts (ATEX)
 - ▲ MI resistance thermometers (ATEX)
 - ▲ Resistance thermometer measuring inserts (ATEX)
 - ▲ Measuring resistors
-
- ▲ Calibration instruments and -systems
 - ▲ Calibrators and simulators
 - ▲ Vendor certificates
 - ▲ Calibration laboratory DKD-K-09701 for temperature
www.centrocal.de and
<http://www.dkd.eu/laboratorien/en/kurzvvd.htm>
-
- ▲ Digital transmitters (EEx(i), HART)
 - ▲ Analog transmitters (EEx(i))
-
- ▲ Protection tubes acc. to DIN 43 772, ASME and special designs to customer specifications
 - ▲ Connection heads form A and B acc. to EN 50 446
 - ▲ Ceramic connection sockets
 - ▲ Connection cables acc. to DIN 43 722 (DIN 43 714), IEC 60 584-3 and special designs

The right to modifications, which serve technical progress, is reserved.

RÖSSEL-Messtechnik GmbH

Lohstraße 2
59368 Werne/GERMANY
Fon: +49 (0) 2389 409-0
Fax: +49 (0) 2389 409-80
Mail: info@roesselwerne.de
Web: www.roesselwerne.de

RÖSSEL-Messtechnik GmbH

Spenerstraße 1
01309 Dresden/GERMANY
Fon: +49 (0) 351 31225-0
Fax: +49 (0) 351 31225-25
Mail: info@roesseldresden.de
Web: www.roesseldresden.de

RÖSSEL

Eikenlaan 253d
2404BP Alphen a/d Rijn
THE NETHERLANDS
Fon: +31 (0) 172 493141
Fax: +31 (0) 172 495043
Mail: info@rossel.nl/Web: www.rossel.nl